

99084

Dimensions

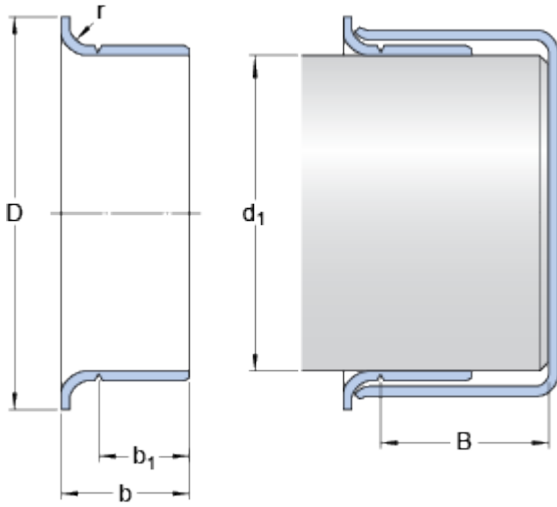

Nominal dimensions

d_1		22	mm
D		30.175	mm
Tolerance outside diameter D	\pm	1.6	mm
b		9.119	mm
Tolerance width b	\pm	0.8	mm
b_1		6.579	mm
Tolerance width b_1	\pm	0.8	mm
B	max.	47.142	mm
r	max.	3.18	mm

Shaft diameter range

d_1	min.	21.869	mm
d_1	max.	21.971	mm